

SHARP

Be Original.

MX-7580N
MX-6580N

Digital Full Colour Multifunctional System

A Smart and Dynamic Colour Document Hub



simply better **business**

A Powerful Document Partner for Simply Better **Business**

The Sharp MX-7580N/6580N is the versatile full-colour document powerhouse you've been waiting for. Its superb range of features give you the power to streamline your office workflow while maintaining consistently high document quality. The MX-7580N/6580N can be customised to meet the differing needs of each user in the workplace. Add this MFP's intuitive ease of use and you've got a new hub of document productivity for your office.



1 Saddle Stitch Finisher

Perfect for booklet making, this option automatically staples, punches holes*, and folds. With the addition of the optional Trimming Module, the edges of saddle-stitched documents can be trimmed to a beautifully consistent finish. Alternatively, you can choose a different optional finisher that supports commonly used finishing functions.

* Requires separate Punch Module option.



Saddle stitching



Sorting

2 Folding Unit

This option performs five types of automated folding for efficient production of direct mail and other items.



3 Inserter

Thanks to two 200-sheet input trays that can handle different types of paper, the optional Inserter can add pre-printed covers and coloured pages to give documents a high-grade, professional look.

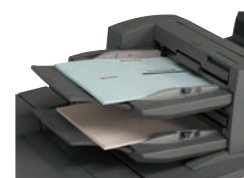

Office users

Simply Better Experience

The MX-7580N/6580N can be customised to meet the needs of individual users, making operation simpler than ever. Such ease of use ensures that everyday jobs are done smoothly and quickly and that professional colour documents are created with ease. This is one MFP that's sure to boost your workplace efficiency.



Business owners / directors

Simply Better Process

The MX-7580N/6580N is a central document hub designed for outstanding productivity and easy operation by every member of your team. This MFP can give your whole office a boost and help you to grab new business opportunities and expand your business.



IT managers / administrators

Simply Better Admin

Simple, secure system administration is the bedrock of every successful business. As a system administrator, setting up a secure environment with the MX-7580N/6580N is easy. Not only does this provide peace of mind, it also enables your entire team to work more efficiently.



4 Curl Correction Unit

To ensure smooth paper transport, top and bottom rollers on this optional unit keep paper from warping.

5 Duplex Single Pass Feeder

Because this highly reliable document feeder scans both sides of two-sided originals in one pass, large-volume documents can be scanned quickly and efficiently.



6 Status Indicator

The optional Status Indicator provides status alerts, including notice of errors, via green and red LED lights that can easily be seen from a distance.

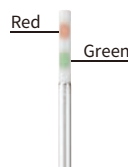

7 10.1-Inch Colour Touchscreen LCD

A user-friendly touchscreen interface incorporating a new Easy UI mode makes it easy and intuitive to operate the MFP.



8 QWERTY Keyboard

Adding the full-size retractable QWERTY keyboard option makes it easy to type in any needed information.



9 Multi Bypass Tray

This option can feed in up to 500 sheets.

10 Large Capacity Trays

Adding 5,000-sheet (2,500 x 2) Large Capacity Trays expands paper capacity for high-volume jobs. 3,000- and 3,500-sheet trays are also optionally available.

HIGH PRODUCTIVITY

Super-Efficient Colour and B/W Output

The MX-7580N/6580N delivers a fast output of 75/65 ppm* in B/W and in full colour. The first copy comes out in just 3.7/4.0 seconds in B/W and 5.1/5.6 seconds in full colour, saving you valuable time when performing multiple short-run jobs.

* A4 (8 1/2" x 11"), long-edge feeding

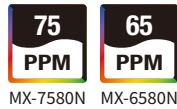

High-Efficiency Scanning

Each MX-7580N/6580N comes equipped with a highly efficient 150-sheet DSPF (duplex single pass feeder). This scans both pages of two-sided documents in one pass. With a scanning speed of up to 100 opm* (one-sided) or 200 opm* (two-sided), this MFP can finish even large projects quickly.

* Originals per minute; when feeding A4 (8 1/2" x 11") sheets



In-Line Finishing Options

The MX-7580N/6580N automates time-consuming finishing tasks and makes it easy to create professional-looking direct mail, handouts, booklets, brochures, and more.

Stapling

(requires optional finisher or saddle stitch finisher)

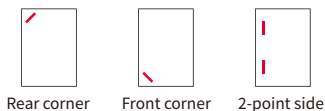

Rear corner Front corner 2-point side

Saddle stitching

(requires optional saddle stitch finisher)

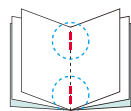

Punching

(requires optional punch module)

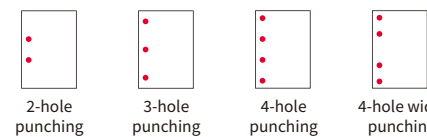

2-hole punching 3-hole punching 4-hole punching 4-hole wide punching

Folding

(requires optional folding unit)



Z-fold C-fold Accordion fold Double fold Half-fold

Trimming

(requires optional trimming module)

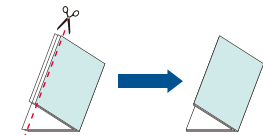

Insertion

(requires optional inserter)

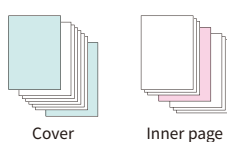

Cover Inner page

Intermediate Toner Hopper for Continuous Runs

Thanks to an intermediate toner hopper, there's no need to stop the MX-7580N/6580N during large-volume copy/print jobs when the toner cartridge needs changing. The MFP can use toner from the toner hopper to continue printing while the empty toner cartridge is replaced with a new one.



Large Paper Capacity

While the MX-7580N/6580N holds a generous 3,100 sheets of paper, this standard capacity can be expanded to meet the needs of high-volume jobs. Adding an optional 500-sheet Multi Bypass Tray and 5,000-sheet (2,500 x 2) Large Capacity Trays boost capacity to 8,500 sheets. And when a tray runs out of paper, the Auto Tray Switching function automatically switches to another tray with the same-sized paper.

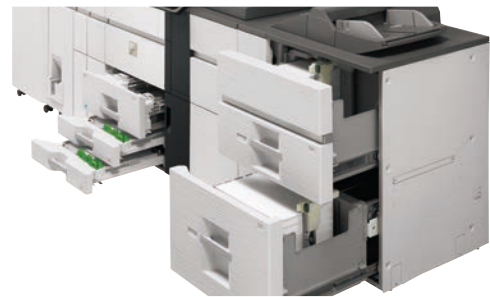

Versatile Paper Handling

• **Paper Sizes:** The MX-7580N/6580N supports an extensive range of standard paper sizes from A5 to SRA3/A3 wide (5 1/2" x 8 1/2" to 13" x 19"), along with custom paper sizes up to 330 x 488 mm (13" x 19.2"). Thanks to its printable area of 319 x 480 mm, this MFP enables full-bleed printing of an A3 image with crop marks or two A4 images with crop marks. It can also handle extra-long paper up to 1,300 mm*.

* Sharp recommends using the optional MX-LT10 for this function. Please contact a Sharp customer representative for details.

• **Paper Weights:** The MX-7580N/6580N handles paper as thin as 55 g/m² and as thick as 300 g/m². Duplexing is possible for paper ranging from 60 g/m² to 300 g/m².

• **Paper Types:** In addition to plain paper, the MX-7580N/6580N accommodates a number of other paper types—including coated, textured, or embossed paper—as well as envelopes. This gives users the flexibility to fulfil diverse printing needs.



Advanced Scan Functions

Automated Scanning*

Using advanced optical character recognition, the MX-7580N/6580N can correct the vertical orientation of pages mixed in upside down. This conveniently saves you the hassle of having to rescan those pages. The MFP can also automatically determine scan resolution and skip blank pages in a multi-page document.

* Easy UI mode only

Multicrop Function

The Multicrop function automatically creates separate files for multiple different-sized documents—such as receipts and bills—that are scanned simultaneously.

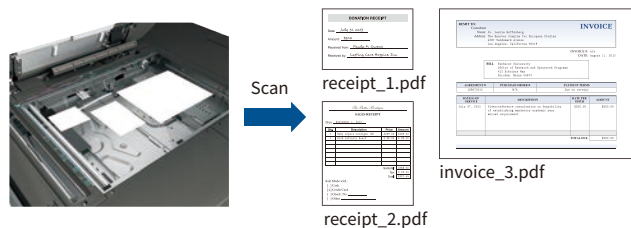

Office Direct Printing

Print common Microsoft® Office files without using a PC. With a MX-7580N/6580N, you can print a Word, Excel®, or PowerPoint® file directly from a mobile device, cloud service, USB drive, or file server.

Note: The actual printout may look different than what is displayed on the computer screen. This function is enabled via DirectOffice™ technology.



Convert Documents via OCR

OCR capability on the MX-7580N/6580N lets you convert a scanned document into a searchable PDF file or into an editable Office Open XML (pptx, xlsx, docx) file. This means you can do speedy text searches, even with large-volume documents, and you can easily copy and paste text data into other applications.

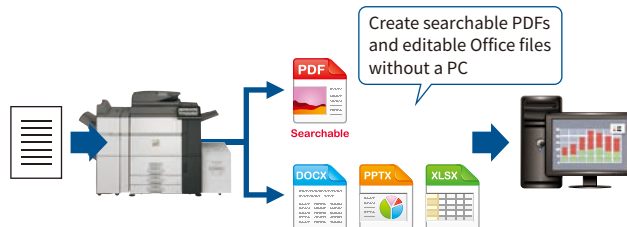

Business Card Management

It's easy to manage a database of business cards with the MX-7580N/6580N. The MFP reads contact details on each card via OCR and then exports those details to a third-party contact management system of your choice.

Versatile Fax Functions (option)

- **Super G3 Fax** function
- **Internet Fax** lets you economically send and receive faxes to and from other T-37-compliant Internet fax machines
- **PC-Fax** lets you send documents created on a PC directly to a recipient's fax machine via a phone line without printing to paper

Fiery® Print Server for Outstanding Quality and Efficiency

Paired with the MX-PE12, an industry-leading EFI™ Fiery embedded print server, the Sharp MX-7580N/6580N becomes a powerful integrated solution for managing professional in-plant and busy on-demand printing environments.



Centralised Control and Automated Management

The MX-PE12 Fiery Server offers a centralised solution that features the award-winning Command WorkStation® with a de facto industry-standard print job management user interface. It's intuitively easy to preview jobs, check their progress, and do reprints. A few clicks and your job is done.

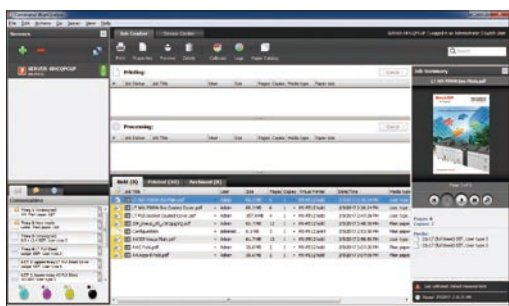

Outstanding Colour across Applications

In demanding print environments, accurate and consistent colour is critical. Integrated Fiery colour management tools provide superior colour control out of the box. Transparencies, drop shadows, and other effects are rendered precisely every time.

Efficient Variable Data Printing

Fiery FreeForm™ is an efficient variable data printing (VDP) format that is especially effective for mass-customised printing of mixed-media documents such as flyers and direct mailers. With FreeForm, fixed images are rastered and variable elements are processed at a later stage. This minimises the processing load on the controller and speeds up the print process. The result is a print driver-based workflow that is very user-friendly.

RELIABILITY

Curl Correction Unit

The optional Curl Correction Unit uses top and bottom rollers to smooth out sheets during paper travel. This keeps the paper from warping before it goes to the finisher and contributes to fast, stable paper feeding.

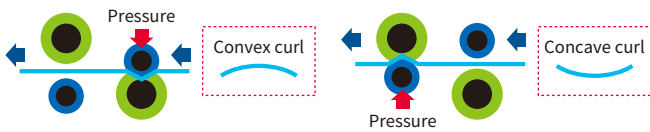

Air-Feed System

For smooth paper handling and travel, an air-feed system on the optional MX-LC13 N Large Capacity Trays minimises paper jams and the feeding of more than one sheet at a time.

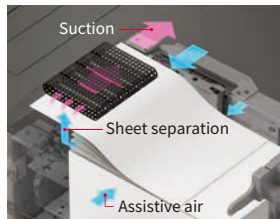

Full Front Access

Particularly convenient during toner cartridge replacement, an unlikely paper jam, and other operations, full front access to all key machine components ensures easy maintenance—and maximum uptime.



Highly Rigid Main Frame

A highly rigid support frame isolates and protects critical machine components in the MX-7580N/6580N, ensuring increased durability and reliability. The unit can withstand heavy use in locations where rapid, high-volume output is demanded.

EASE OF USE

10.1-Inch Colour LCD Touchscreen

A user-friendly touchscreen interface incorporating an Easy UI mode makes it easy for anyone to use the MFP's advanced functions. In this mode, simple function icons are displayed on the LCD touchscreen. Each user can customise the home screen by drag-and-dropping icons for commonly used functions, making for smoother, more efficient operation. The Advanced Preview function, meanwhile, lets you check document finishes and page layout in advance, edit pages easily, and preview documents in various modes.

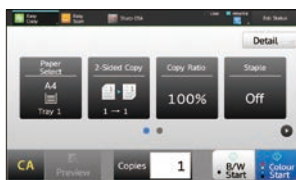

Easy Copy mode

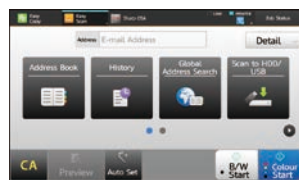

Easy Scan mode

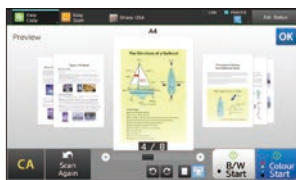

Preview mode (3D)



Edit mode (rotate)

Printer Driver with Easy Setup

The printer driver setup window features a simple design that includes larger buttons and drop-down menus, making it easier than ever to use printer functions.

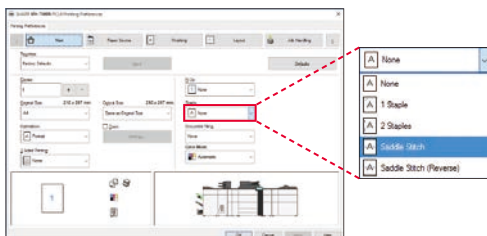

Free-Tilting Control Panel

The control panel can be tilted freely at various angles for easy viewing and easy operation, even from a wheelchair.



Direct Printing/Scanning with USB Drives

Insert a USB drive into the MFP and a print/scan command screen will automatically pop up on the LCD. Right away you can print files from the USB drive—which are displayed as thumbnails—or you can scan documents directly to the USB drive.



Address Book

The address book has an easy-to-see layout that includes Frequent Use buttons, a separate Address list, and larger buttons, scroll bar, and text. This user-friendly design makes selecting the right scan/fax destinations more effortless than ever.

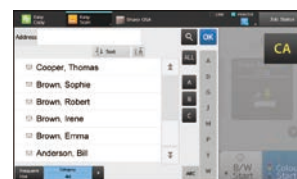

Integrated Device Management

As a system administrator, you can get the most out of a Sharp document system by using Sharp's efficiency-boosting device management tools. From a single location, you can use Sharp Remote Device Manager* (SRDM) to manage multiple Sharp MFPs.

* Contact a Sharp customer representative for availability and other details.

Wide Colour Gamut

By thoroughly revamping the imaging process, Sharp was able to expand the colour gamut for this MFP. As a result, colour reproduction is more faithful and vivid compared to previous models.

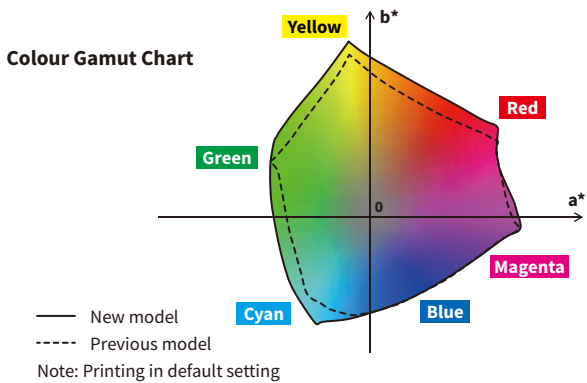

Line Width Adjustment

This function adjusts the width of lines. Fine lines, which are otherwise difficult to render properly, turn out sharp and crisp. Intricate line drawings, complex graphs and charts, and detailed spreadsheets are reproduced with exceptional quality and precision.

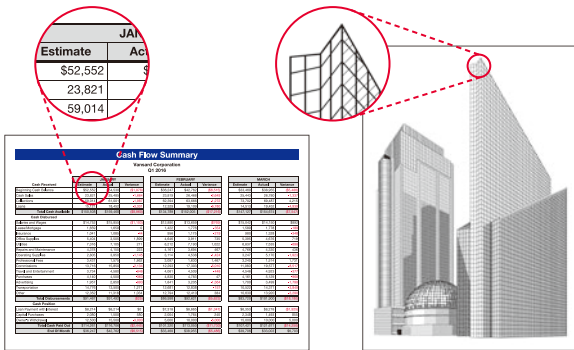

High-Resolution Output

The MFP's print engine supports 1,200 × 1,200 dpi printing and copying*. Digital smoothing technology delivers print and copy resolution at the equivalent of 9,600 × 600 dpi, giving you ultra-clear image quality. Fine lines and small text come out looking crisper and easier to read.

* Copying in B/W only.

True Adobe® PostScript® 3™

For better graphics handling, the MX-7580N/6580N comes standard with true Adobe PostScript 3. In addition, the PostScript driver allows you to use the dot screening technique so that you can emulate the high-quality printing of commercial offset printers.

Developer Refresh System

By discharging old developer little by little and continuously replacing it with new developer, this system prevents developer deterioration, ensuring stable print quality over the long term.

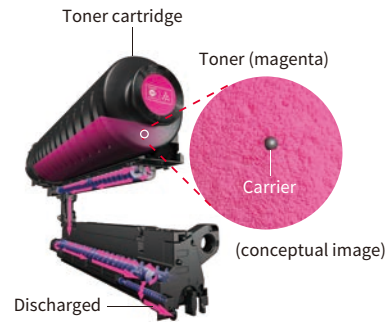

Auto Process Control

To maintain consistently high image quality during large-volume print jobs, the MX-7580N/6580N employs a periodic colour calibration system. Image density sensors monitor image consistency to minimise colour variance between pages. As an added advantage, the MFP makes the necessary colour adjustments without stopping the print job, ensuring time-efficient printing.

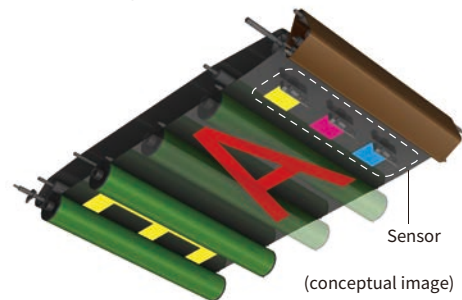

Easy, High-Quality Copying and Scanning

Through an advanced three-step process, **Auto Colour Mode** provides fully automated copying and scanning in both colour and B/W—with a simple press of the Start button. Here's how it works: **Auto Colour Selection** automatically determines whether a page is colour or B/W. **Auto Original Type Selection** then analyses page contents to distinguish between different components (such as photos and text) and selects the appropriate mode. Finally, **Background Suppression** automatically removes unnecessary background colour.

Auto Colour Mode

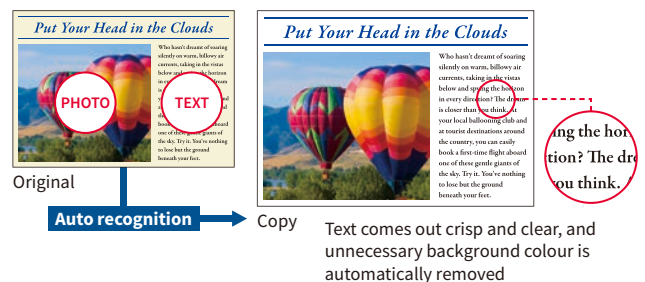

SECURE INFORMATION SHARING

Link to Cloud Services*

An MX-7580N/6580N doesn't just connect to your local server. It also connects with cloud services directly from the MFP's control panel. You can upload scanned data to Google Drive™, OneDrive® for Business, or SharePoint® Online—or print directly from any of them. Using a cloud service like this can save you the time and cost of setting up and managing a server within your company. Once you log into the MFP, you can quickly access multiple software services without having to sign in to each one separately. It's a true time-saver that gets your document jobs finished faster.

* Requires optional MX-AMX2.

Link with Mail Servers

Scanned data can be conveniently sent via your regular Gmail™ or Microsoft Exchange account. Sending e-mail is as easy as choosing a recipient from your address book on the mail server. Scanned data that you send can be stored on the mail server with other sent items.

Sharp OSA* (Open Systems Architecture)

Innovative Sharp OSA technology allows you to interact with critical business and network applications right from the LCD control panel, offering a new realm of control and convenience. And since Sharp OSA utilises industry-standard network protocols, the MX-7580N/6580N can easily integrate with document management systems, enterprise resource planning software, workflow applications, and more. The latest version of Sharp OSA can reach beyond the firewall, enabling extensive system construction as well as services delivered over the Internet such as cloud services.

In this way, Sharp OSA provides a foundation for cost reductions and information sharing across the entire company organisation—effectively enhancing total business efficiency.

* Requires optional MX-AMX2 and/or MX-AMX3.

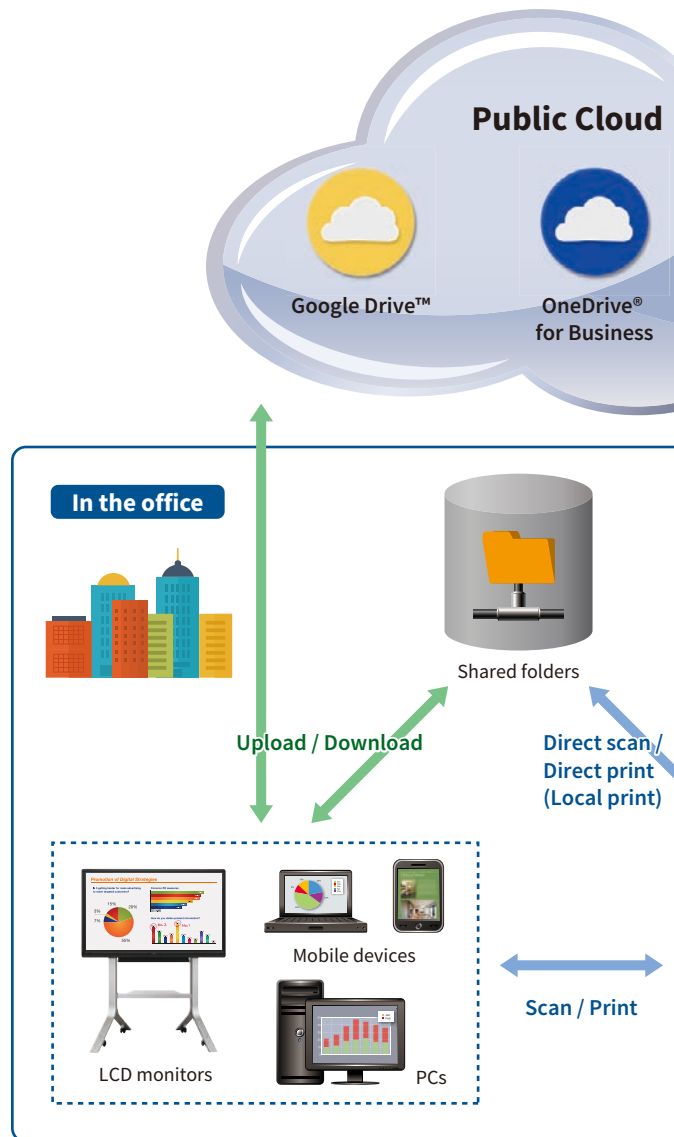

Seamless Document Workflow and Management

Multiple Distribution of Scanned Files

Scanned documents can be distributed in a number of ways. For example, they can be sent as e-mail attachments or they can be scanned directly to an FTP server for storage. A standard-equipped compact PDF function ensures that PDF files are sent and received smoothly.

Sharpdesk Document Management Software

Sharpdesk is an original Sharp application that provides integrated desktop management of documents in over 200 file formats, including scanned paper-based documents and those created with popular applications such as Word. With Sharpdesk, documents can be organised, edited, searched, and distributed with simple drag-and-drop operation. Features include thumbnail viewing, annotation tools for paper-free proofreading, optical character recognition, the ability to combine different types of files into a single document, and more.

Document Filing

Document Filing allows processed data to be saved in designated folders on the MFP's hard disk. From there, it can be instantly recalled for printing and sending at a later time.

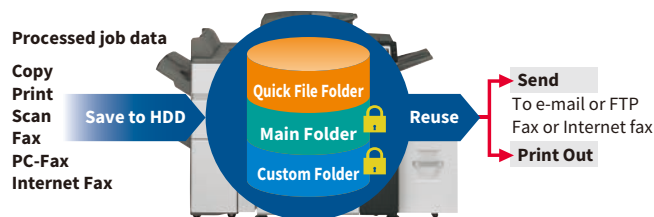

Easy Sharing of Application Files

The MX-7580N/6580N's hard disk enables files created with applications such as Word and Excel to be saved in their original file format and shared across the office network.

Note: Sharp recommends backing up data saved to the MFP's hard disk.

Two-Way Sharing with Mobile Devices

Connecting an MX-7580N/6580N to one or more mobile devices is easy, and it expands your options for sharing data. Not only can you send scanned documents to mobile devices such as smartphones and tablets, you can also print documents or photos sent from those devices.

Sharpdesk Mobile*

Sharpdesk Mobile is a mobile print/scan application that connects the MFP to mobile devices via wireless LAN.

* Availability varies by country/region. For details, see the Sharpdesk Mobile support Web site: http://sharp-world.com/products/copier/docu_solutions/mobile/sharpdesk_mobile/

Mobile Printing Services

The MX-7580N/6580N supports Google Cloud Print™, AirPrint, and Sharp Print Service Plugin.

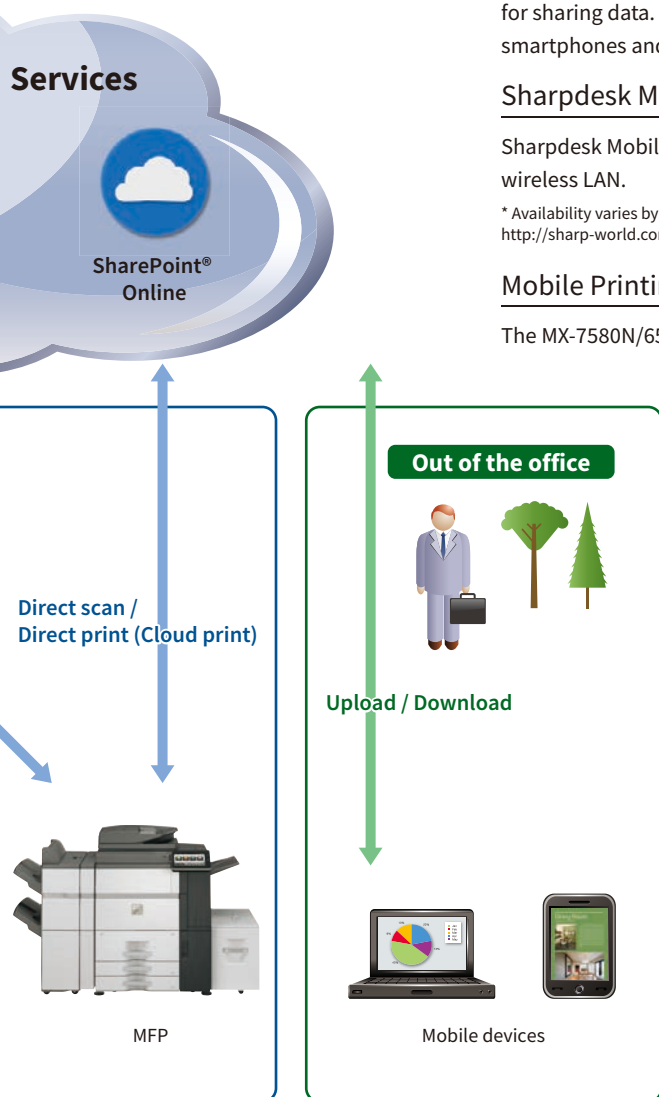

Wireless Connections*

The MX-7580N/6580N offers ultra-handry wireless access via two easy modes, enabling convenient access to the MFP even from places where a wired LAN is not available.

* Availability varies by country/region.

Infrastructure mode wirelessly connects the MFP to mobile PCs/devices via a commercially available wireless LAN router.

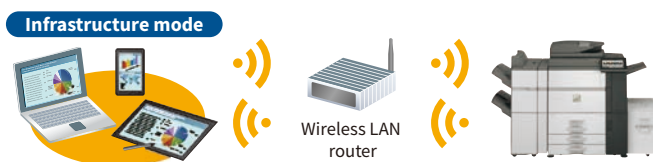

Access point mode wirelessly connects a LAN-wired MFP to mobile PCs/devices without going through a wireless LAN router.



Note: External networks cannot be accessed via the MFP. Up to five mobile devices can be wirelessly connected to the MFP at the same time.

Multi-Layered Security

Network Security and Access Control

- **S/MIME** provides secure e-mail communications*
* Only when e-mailing scanned data.
- **SSL** (secure sockets layer) and **IPsec** data encryption technologies ensure secure network communications
- **User Authentication** covering up to 1,000 users prevents unauthorised MFP use by requiring access passwords
- **Active Directory®** enables integrated management of user credentials, thereby providing a highly secure and efficient environment for system administrators
- **Single sign-on** brings easy access to public cloud services and internal network folders by simply logging into the MFP—there's no need to re-enter your IDs and passwords



Document Protection

- **Document Control** prevents unauthorised use of confidential documents by embedding copy prevention data in them
Note: Requires optional Data Security Kit. May not work with certain types of paper, documents (such as those with a large volume of photos), or MFP settings.
- **Hidden Pattern Copy/Print** embeds a watermark, such as “Confidential” or “Not for Copy,” onto a document
- **Tracking Information Print** prints the MFP user's name, the date, job ID, and other specifics on printouts, making it possible to track documents

Data Protection

- Job data is automatically **encrypted** before being saved to the MFP's internal storage. Once a job is finished, its encrypted data is **erased** by up to 10 automatic overwrites.
Note: Contact a Sharp customer representative for details on activating this function.
- Retained data can be **initialised** when it's time to replace the MFP, preventing the leakage of confidential information

ENVIRONMENT-FRIENDLY

Auto Power Shut-Off Mode

Based on prior usage patterns, the MFP automatically determines how long to wait before going into auto power shut-off mode. Shortly before this mode begins, a message appears on the LCD indicating that the MFP will soon shut down and giving you the option to continue operation.

Power ON/OFF Scheduling

This function automatically turns the MX-7580N/6580N on or off according to time schedules set by the administrator.

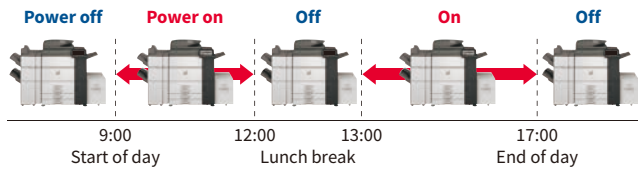

Eco Scan

The Eco Scan function saves energy by keeping the fusing system shut down during jobs that don't require its use—for example, during image sending and Document Filing.

Eco Recommendation

This function suggests environmentally friendly settings before a print*/copy command is executed from the control panel.

* For printing Document Filing data and direct printing (FTP/SMB/USB).



Low Power Consumption

By pursuing technological excellence in all aspects of this MFP, including its hardware, firmware, and electrical system, Sharp has succeeded in developing a product with exceptional energy efficiency. As a result, the MX-7580N/6580N boasts a TEC value* that is significantly lower than the maximum allowable values determined by ENERGY STAR®.

* Typical amount of energy consumed in a hypothetical week measured as stipulated under the ENERGY STAR programme.



SYSTEM CONFIGURATION

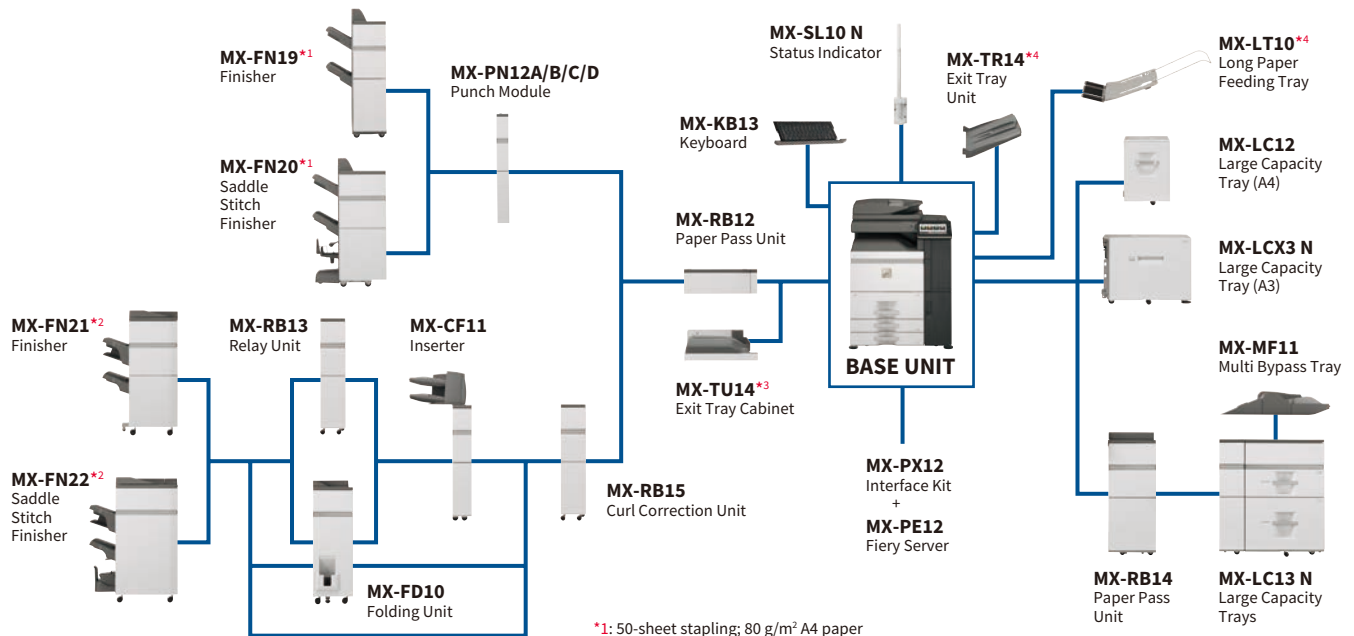

- *1: 50-sheet stapling; 80 g/m² A4 paper
- *2: 100-sheet stapling; 80 g/m² A4 paper
- *3: Required for min. configuration
- *4: Cannot be used with MX-RB14, MX-LC13 N, and MX-MF11
- *5: Available at a later date

MX-PN13A/B/C/D
Punch Module (for MX-FN21/FN22)

MX-TM10
Trimming Module (for MX-FN22)

MX-PF10
Barcode Font Kit

AR-SU1
Stamp Unit

MX-FX15
Fax Expansion Kit

MX-FWX1
Internet Fax Expansion Kit

MX-USX1/X5
Sharpdesk 1/5-License Kit

MX-US10/50/A0
Sharpdesk 10/50/100-License Kit

MX-AMX1
Application Integration Module

MX-AMX2
Application Communication Module

MX-AMX3
External Account Module

MX-FR55U*5
Data Security Kit

Certain options may not be available in some areas.

SPECIFICATIONS FOR OPTIONS

MX-FN19 Finisher

Paper size	Non offset	SRA3/A3 wide (13" x 19") to A5 (5 1/2" x 8 1/2")* ¹ Custom sizes up to 330 x 488 mm (13" x 19.2")
	Offset/staple	A3 (11" x 17") to B5* ² (8 1/2" x 11")
Paper weight	Non offset	55 g/m ² to 300 g/m ² (13 lbs bond to 110 lbs cover)
	Offset/staple	55 g/m ² to 256 g/m ² (13 lbs bond to 140 lbs index)
Paper capacity (80 g/m ²)	Upper tray	1,550 sheets (up to A4), 650 sheets (up to SRA3)
	Lower tray	2,450 sheets (up to A4), 650 sheets (up to SRA3)
Stapling capacity* ³		50 sheets (A4, B5), 30 sheets (A3, B4, A4* ⁴)
Staple position		3 locations (front, rear, 2 staples)
Power requirements		Supplied by main unit
Dimensions	With tray stored	530 x 662 x 1,100 mm (W x D x H)
	With tray extended	660 x 662 x 1,100 mm (W x D x H)
Weight		42 kg

MX-FN20 Saddle Stitch Finisher

Paper size	Non offset	SRA3/A3 wide (13" x 19") to A5 (5 1/2" x 8 1/2")* ¹ Custom sizes up to 330 x 488 mm (13" x 19.2")
	Offset/staple	A3 (11" x 17") to B5* ² (8 1/2" x 11")
Paper weight	Non offset	55 g/m ² to 300 g/m ² (13 lbs bond to 110 lbs cover)
	Offset/staple	55 g/m ² to 256 g/m ² (13 lbs bond to 140 lbs index)
	Saddle stitch	55 g/m ² to 105 g/m ² (13 lbs bond to 28 lbs bond)
	Folding	60 g/m ² to 105 g/m ² (16 lbs bond to 28 lbs bond)
Paper capacity (80 g/m ²)	Upper tray	1,550 sheets (up to A4), 650 sheets (up to SRA3)
	Lower tray	2,450 sheets (up to A4), 650 sheets (up to SRA3)
	Saddle stitch tray	1-5 sheets: 25 sets, 6-10 sheets: 15 sets, 11-15 sheets: 10 sets
Stapling capacity* ³		50 sheets (A4, B5), 30 sheets (A3, B4, A4* ⁴)
Staple position		3 locations (front, rear, 2 staples)
Power requirements		Supplied by main unit
Dimensions	With tray stored	642 x 662 x 1,100 mm (W x D x H)
	With tray extended	772 x 662 x 1,100 mm (W x D x H)
Weight		72 kg

MX-FN21 Finisher

Paper size	Non offset	SRA3/A3 wide (13" x 19") to A5 (5 1/2" x 8 1/2")* ¹ Custom sizes up to 330 x 488 mm (13" x 19.2")
	Offset/staple	A3 (11" x 17") to B5* ² (8 1/2" x 11")
Paper weight	Non offset/offset	55 g/m ² to 300 g/m ² (13 lbs bond to 110 lbs cover)
	Staple/saddle stitch	60 g/m ² to 300 g/m ² (16 lbs bond to 110 lbs cover)
	Folding	60 g/m ² to 220 g/m ² (16 lbs bond to 80 lbs cover)
Paper capacity (80 g/m ²)	Upper tray	1,500 sheets (up to A4), 750 sheets (up to SRA3)
	Middle tray	250 sheets (up to A4), 125 sheets (up to SRA3)
	Lower tray	2,500 sheets (up to A4), 750 sheets (up to SRA3)
Stapling capacity* ³		100 sheets (A4, B5), 50 sheets (A3, B4, A4* ⁴)
Staple position		3 locations (front, rear, 2 staples)
Power consumption (max.)		200 W, 350 W with MX-FD10
Power requirements		230V, 10A
Dimensions	With tray stored	654 x 765 x 1,040 mm (W x D x H)
	With tray extended	782 x 765 x 1,040 mm (W x D x H)
Weight		61 kg

MX-FN22 Saddle Stitch Finisher

Paper size	Non offset	SRA3/A3 wide (13" x 19") to A5 (5 1/2" x 8 1/2")* ¹ Custom sizes up to 330 x 488 mm (13" x 19.2")
	Offset/staple	A3 (11" x 17") to B5* ² (8 1/2" x 11")
Paper weight	Non offset/offset	55 g/m ² to 300 g/m ² (13 lbs bond to 110 lbs cover)
	Staple/saddle stitch	60 g/m ² to 300 g/m ² (16 lbs bond to 110 lbs cover)
	Folding* ⁵	60 g/m ² to 220 g/m ² (16 lbs bond to 80 lbs cover)
Paper capacity (80 g/m ²)	Upper tray	1,500 sheets (up to A4), 750 sheets (up to SRA3)
	Middle tray	250 sheets (up to A4), 125 sheets (up to SRA3)
	Lower tray	2,500 sheets (up to A4), 750 sheets (up to SRA3)
	Saddle stitch tray	1-5 sheets: 25 sets, 6-10 sheets: 15 sets, 11-15 sheets: 10 sets, 16-20 sheets: 5 sets
Stapling capacity* ³		100 sheets (A4, B5), 50 sheets (A3, B4, A4* ⁴)
Staple position		3 locations (front, rear, 2 staples)
Power consumption (max.)		200 W, 350 W with MX-FD10
Power requirements		230V, 10A
Dimensions	With tray stored	767 x 765 x 1,040 mm (W x D x H)
	With tray extended	896 x 765 x 1,040 mm (W x D x H)
Weight		108 kg

MX-TM10 Trimming Module (for MX-FN22)

Paper size		SRA3/A3 wide (13" x 19") to A4 (8 1/2" x 11")* ⁴ Custom sizes up to 330 x 488 mm (13" x 19.2")
Paper weight		60 g/m ² to 300 g/m ² (16 lbs bond to 110 lbs cover)
Acceptable number of sheets* ⁵		2-20 sheets (60 g/m ² to 81.4 g/m ²), 2-10 sheets (more than 81.4 g/m ² to 105 g/m ²), 2-3 sheets (more than 105 g/m ² to 220 g/m ²)
Trim width		2 mm to 20 mm in 0.1 mm increments
Power requirements		Powered by MX-FN22 Finisher
Dimensions		251 x 625 x 403 mm (W x D x H)
Weight		32 kg

Punch Modules

Model name	For the MX-FN19/20 For the MX-FN21/22	MX-PN12A MX-PN13A	MX-PN12B MX-PN13B	MX-PN12C MX-PN13C	MX-PN12D MX-PN13D
Number of holes		2	3/2	4/2	4 (wide)
Paper weight		55 to 256 g/m ²			
Power requirements		Powered by MX-FN19/FN20/FN21/FN22 Finisher			

MX-FD10 Folding Unit

Folding mode		Z-fold, C-fold, Accordion-fold, Double-fold, Half-fold
Paper size	Z-/Half-fold* ⁶ C-/Accordion-/Double-fold	A3 (11" x 17") to A4 (8 1/2" x 11")* ⁴ A4 (8 1/2" x 11")* ⁴
Paper capacity (80 g/m ²)	Z-/Half-fold* ⁶ C-/Accordion-fold Double-fold	30 sheets (up to A3), 10 sheets (A4* ⁴) 40 sheets (A4) 25 sheets (A4)
Paper weight		52 g/m ² to 105 g/m ² (13 lbs bond to 28 lbs bond)
Power requirements		Powered by MX-FN21/FN22 Finisher
Dimensions		336 x 793 x 1,050 mm (W x D x H)
Weight		66 kg

MX-RB15 Curl Correction Unit

Paper size		SRA3/A3 wide (13" x 19") to A5 (5 1/2" x 8 1/2")* ¹ Custom sizes up to 330 x 488 mm (13" x 19.2")
Paper weight		55 g/m ² to 300 g/m ² (13 lbs bond to 110 lbs cover)
Power requirements		Supplied by main unit
Dimensions		214 x 760 x 986 mm (W x D x H)
Weight		18.4 kg

MX-CF11 Inserter

Paper size		SRA3/A3 wide (13" x 19") to A5 (5 1/2" x 8 1/2")* ¹ Custom sizes up to 330 x 488 mm (13" x 19.2")
Paper weight		60 g/m ² to 220 g/m ² (16 lbs bond to 80 lbs cover)
Paper capacity (80 g/m ²)	Upper/lower tray	200 sheets/each
Power requirements		Supplied by main unit
Dimensions	With tray stored	540 x 760 x 1,276 mm (W x D x H)
	With tray extended	690 x 760 x 1,276 mm (W x D x H)
Weight		45 kg

MX-LC12 Large Capacity Tray (A4)

Paper size		A4, B5 (8 1/2" x 11")* ⁷
Paper weight		60 g/m ² to 220 g/m ² (16 lbs bond to 80 lbs cover)
Paper capacity (80 g/m ²)		3,500 sheets
Power requirements		Supplied by main unit
Dimensions		376 x 576 x 524 mm (W x D x H)
Weight		28.5 kg

MX-LCX3 N Large Capacity Tray (A3)

Paper size		SRA3/A3 wide (13" x 19") to B5* ² (8 1/2" x 11")
Paper weight		60 g/m ² to 220 g/m ² (16 lbs bond to 80 lbs cover)
Paper capacity (80 g/m ²)		3,000 sheets
Power requirements		Supplied by main unit
Dimensions		670 x 570 x 525 mm (W x D x H)
Weight		50 kg

MX-MF11 Multi Bypass Tray (for MX-LC13 N)

Paper size		SRA3/A3 wide (13" x 19") to A5 (5 1/2" x 8 1/2")* ¹ Custom sizes up to 330 x 488 mm (13" x 19.2")
Paper weight		55 g/m ² to 220 g/m ² (13 lbs bond to 80 lbs cover)
Paper capacity (80 g/m ²)		500 sheets
Power requirements		Powered by MX-LC13 N Large Capacity Trays
Dimensions	With tray stored	705 x 556 x 203 mm (W x D x H)
	With tray extended	878 x 556 x 203 mm (W x D x H)
Weight		18 kg

MX-LC13 N Large Capacity Trays

Paper size		SRA3/A3 wide (13" x 19") to B5 (7 1/4" x 10 1/2")* ⁸ Custom sizes up to 330 x 488 mm (13" x 19.2")
Paper weight		55 g/m ² to 300 g/m ² (13 lbs bond to 110 lbs cover)
Paper capacity (80 g/m ²)	Upper/lower tray	2,500 sheets/each
Power consumption		900 W
Power requirements (max.)		230V, 10A
Dimensions		895 x 763 x 986 mm (W x D x H)
Weight		131 kg

MX-LT10 Long Paper Feeding Tray

Paper size	Width	90 mm to 305 mm
	Length	489 mm to 1,300 mm
Paper capacity		1 sheet
Dimensions	With tray stored	338 x 195 x 107 mm (W x D x H)
	With tray extended	581 x 195 x 103 mm (W x D x H)
Weight		0.8 kg

*1 Only short-edge feeding can be used with A5 (5 1/2" x 8 1/2") paper. *2 Only long-edge feeding can be used with B5 paper. *3 Using 80 g/m² paper, can include back and front covers (total of 2 sheets) of heaviest paper that can be stapled. *4 Only short-edge feeding can be used with A4 (8 1/2" x 11") paper. *5 Can include a single cover sheet of 300 g/m² or less. *6 Z-fold and half-fold pages are ejected from the finisher (MX-FN21/FN22). *7 Only long-edge feeding can be used with A4 and B5 (8 1/2" x 11") paper. *8 Only short-edge feeding can be used with 7 1/4" x 10 1/2" paper.

SPECIFICATIONS (tentative)

General	
Type	Console
Engine speed	A4 (8 1/2" x 11") ^{*1} : Max. 75/65 ppm A3 (11" x 17") ^{*1} : Max. 36/33 ppm SRA3: Max. 35/31 ppm
Control panel display	10.1-inch colour LCD touchscreen
Paper size	Max. SRA3/A3 wide (13" x 19"), min. A5 (5 1/2" x 8 1/2") ^{*2}
Paper capacity (80 g/m ²)	Standard: 3,100 sheets (1,200-sheet tray, 800-sheet tray, 500-sheet tray x 2, and 100-sheet multi bypass tray) Maximum: 8,500 sheets (3,000 sheets & optional 2 x 2,500-sheet tray and 500-sheet multi bypass tray)
Paper weight	Tray 1&2: 60 g/m ² to 105 g/m ² (16 lbs bond to 28 lbs bond) Tray 3&4: 60 g/m ² to 220 g/m ² (16 lbs bond to 80 lbs cover) Multi bypass tray: 55 g/m ² to 300 g/m ² (13 lbs bond to 110 lbs cover) Multi bypass tray (MX-MF11): 55 g/m ² to 220 g/m ² (13 lbs bond to 80 lbs cover) Large capacity tray (MX-LC12, MX-LC3 N): 60 g/m ² to 220 g/m ² (16 lbs bond to 80 lbs cover) Large capacity tray (MX-LC13 N): 55 g/m ² to 300 g/m ² (13 lbs bond to 110 lbs cover)
Warm-up time ^{*3}	55 sec.
Memory	6GB (copy/print shared) 1TB HDD ^{*4}
Power requirements	220 V to 240 V, 8 A, 50/60 Hz (10 A plug x 2)
Power consumption (max.)	Max. 3.84 kW (220 V to 240 V)
Dimensions (W x D x H)	845 x 844 x 1,221 mm (33 9/32" x 33 15/64" x 48 5/64")
Weight (approx.)	211 kg (465.2 lbs)

Copier	
Original paper size	Max. A3 (11" x 17")
First copy time ^{*5}	Full colour: 5.1/5.6 sec. B/W: 3.7/4.0 sec.
Continuous copy	Max. 9,999 copies
Resolution	Scan (colour): 600 x 600 dpi Scan (B/W): 600 x 600 dpi, 600 x 400 dpi Print (colour): 600 x 600 dpi, 9,600 (equivalent) x 600 dpi (depending on copy mode) Print (B/W): 1,200 x 1,200 dpi, 600 x 600 dpi, 9,600 (equivalent) x 600 dpi (depending on copy mode) Equivalent to 256 levels
Gradation	Equivalent to 256 levels
Zoom range	25% to 400% (25% to 200% using DSPF) in 1% increments
Preset copy ratios	Metric: 10 ratios (5R/5E), inch: 8 ratios (4R/4E)

Network Scanner	
Scan method	Push scan (via control panel) Pull scan (TWAIN-compliant application)
Scan speed ^{*6} (colour & B/W)	One-sided: Max. 100 originals/min. Two-sided: Max. 200 originals/min.
Resolution	Push scan: 100, 150, 200, 300, 400, 600 dpi Pull scan: 75, 100, 150, 200, 300, 400, 600 dpi 50 dpi to 9,600 dpi via user setting ^{*7}
File formats	TIFF, PDF, PDF/A, encrypted PDF, XPS, compact PDF ^{*8} , JPEG ^{*9} , searchable PDF, OOXML (pptx, xlsx, docx), text (TXT), rich text (RTF)
Scanner utility	Sharpdesk
Scan destinations	Scan to e-mail/desktop/FTP server/network folder (SMB)/USB drive/HDD

Document Filing	
Document filing capacity ^{*9}	Main and custom folders: 35,000 pages or 5,000 files Quick file folder: 10,000 pages or 1,000 files
Stored jobs ^{*10}	Copy, print, scan, fax
Storage folders	Quick file folder, main folder, custom folder (max. 1,000 folders)

^{*1}: Long-edge feeding. ^{*2}: Only short-edge feeding can be used with A5 (5 1/2" x 8 1/2") paper. ^{*3}: At rated voltage, 23°C (73.4°F). May vary depending on operating conditions and environment. ^{*4}: HDD capacity depends on procurement and sourcing status. ^{*5}: Short-edge feeding of A4 (8 1/2" x 11") sheets from 2nd paper tray, using document glass, without Auto Colour Selection and Auto Colour mode, MFP in fully ready condition. May vary depending on operating conditions and environment. ^{*6}: Based on Sharp's A4 standard chart, using document feeder and long-edge feeding. Using factory default settings with Auto Colour Selection off. Scan speed will vary depending on the type of document and the scan settings. ^{*7}: Resolution will vary depending on the size of the scanned area. ^{*8}: Colour/greyscale only. ^{*9}: Storage capacity will vary depending on the type of document and the scan settings. ^{*10}: Some features require option(s). ^{*11}: Based on Sharp's standard chart with approx. 700 characters (A4 or 8 1/2" x 11" long-edge feeding) at standard resolution in Super G3 mode, 33,600 bps, JBIG compression.

Network Printer	
Resolution	1,200 x 1,200 dpi, 600 x 600 dpi, 9,600 (equivalent) x 600 dpi
Interface	USB 2.0 (host, high-speed), 10Base-T/100Base-TX/1000Base-T
Supported OS	Windows Server [®] 2008, Windows Server [®] 2008 R2, Windows Server [®] 2012, Windows Server [®] 2012 R2, Windows Server [®] 2016, Windows Vista [®] , Windows [®] 7, Windows [®] 8.1, Windows [®] 10, Mac OS X 10.6, 10.7, 10.8, 10.9, 10.10, 10.11, macOS Sierra
Network protocols	TCP/IP
Printing protocols	LPR, Raw TCP (port 9100), POP3 (e-mail printing), HTTP, FTP for downloading print files, IPP, SMB, WSD
PDL	PCL 6 emulation, Adobe [®] PostScript [®] 3 [™]
Available fonts	80 fonts for PCL, 139 fonts for Adobe PostScript 3

Fieri [®] Print Server (optional MX-PE12 and MX-PX12 required)	
Type	Embedded server
System software	Fieri FS200
Operating system	Linux
CPU	Intel [®] Pentium [®] G1820, 2.7 GHz
Memory	2GB RAM 500GB HDD
Resolution	1,200 x 1,200 dpi, 600 x 600 dpi (PS, PCL)
Supported OS	Windows Server 2008, Windows Server 2008 R2, Windows Server 2012, Windows Server 2012 R2, Windows Server 2016, Windows Vista, Windows 7, Windows 8.1, Windows 10, Mac OS X 10.7, 10.8, 10.9, 10.10, 10.11, macOS Sierra
Network protocols	TCP/IP, LDAP, iPrint thru LPR
Interface	Gigabit Ethernet
Printing protocols	LPD, PAP, SMB, port 9100, IPP 1.1, FTP printing, e-mail print, WSD
PDL	Adobe PostScript 3
Available fonts	138 fonts for Adobe PostScript 3
Power requirements	100 V to 240 V, 50/60 Hz
Power consumption	Max. 0.18 kW
Dimensions (W x D x H)	271.5 x 296.9 x 89.4 mm (10 45/64" x 11 45/64" x 3 17/32")
Weight (approx.)	5.6 kg (12.3 lbs)

Facsimile (optional MX-FX15 required)	
Compression method	MH/MR/MMR/JBIG
Communication protocol	Super G3/G3
Transmission time	Less than 3 seconds ^{*11}
Modem speed	33,600 bps to 2,400 bps with automatic fallback
Transmission resolution	From Standard (203.2 x 97.8 dpi) to Ultra Fine (406.4 x 391 dpi)
Recording size	A3 to A5 (11" x 17" to 5 1/2" x 8 1/2")
Memory	1GB (built-in)
Greyscale levels	Equivalent to 256 levels

• Design and specifications are subject to change without prior notice. • The ENERGY STAR logo is a certification mark and may only be used to certify products that have been determined to meet the ENERGY STAR programme requirements. ENERGY STAR and the ENERGY STAR mark are registered trademarks owned by the US Environmental Protection Agency. The ENERGY STAR guidelines apply to products only in the US, the EU, Japan, Canada, Australia, New Zealand, and Taiwan. • Microsoft, PowerPoint, Excel, SharePoint, OneDrive, Active Directory, Windows, Windows Server, and Windows Vista are either registered trademarks or trademarks of Microsoft Corporation in the US and/or other countries. Command WorkStation, the EFI logo, Fieri, and the Fieri logo are registered trademarks of Electronics for Imaging, Inc. in the US and/or certain other countries. EFI and FreeForm are trademarks of Electronics for Imaging, Inc. in the US and/or certain other countries. Adobe and PostScript 3 are either registered trademarks or trademarks of Adobe Systems Incorporated in the US and/or other countries. Google Drive, Google Cloud Print, and Gmail are trademarks of Google Inc. The Google Drive trademark is used with permission from Google Inc. AirPrint, Mac, OS X, and macOS are trademarks of Apple Inc., registered in the US and other countries. PCL is a registered trademark of Hewlett-Packard Company. Intel and Pentium are trademarks of Intel Corporation or its subsidiaries in the US and/or other countries. DirectOffice is a product of CSR Imaging US, LP. DirectOffice is a trademark of CSR Imaging US, LP, registered in the US and other countries, used with permission. All other brand names and product names may be trademarks or registered trademarks of their respective owners.

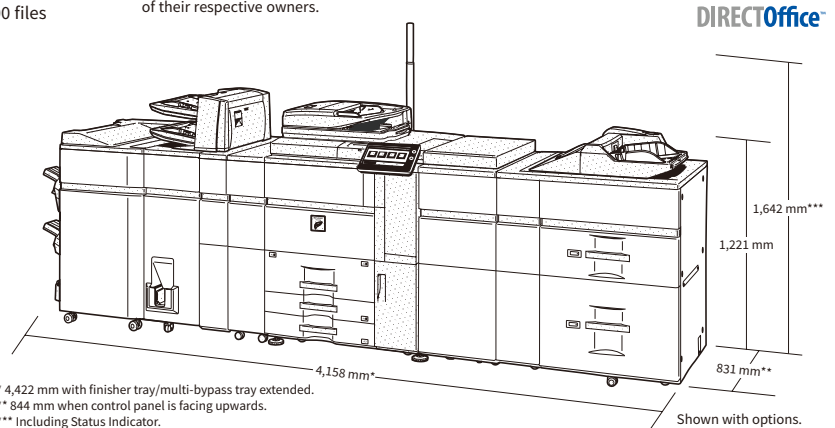

Distributed by: